

OSCAR MASCHERA 

SEASONS

DESIGNED
BY NESTOR PERKAL



SEASONS

Mobili contenitori in legno rivestiti in cuoio

Campagna alle porte della città. La metropolitana attraversa e supera tutta la metropoli al buio. C'è solo una luce all'orizzonte, la mia meta.

Per arrivarci mi hanno consegnato una mappa disegnata su un biglietto: una specie di intarsio. Ombre di alberi, un cancello di legno spinto dal vento, il portone nero. Quando sono entrato nella casa gli invitati non erano ancora arrivati, non c'era nessuno.

Solitari, nel cuore della sala, stavano due "mobili". Sembravano le porte chiuse di mondi sconosciuti. Non so da dove è arrivata la luce abbagliante di un faro marittimo. Ho visto tutto distintamente.

Ecco gli intarsi! Un segnale per me: ero nel posto giusto.

Marco Triches, marzo 2022

SEASONS

Storage furniture in leather-covered wood

Countryside just outside town. The subway crosses the city in the dark and comes out on the other side. There's just one light on the horizon, and I'm heading for it.

To guide me there, they've given me a map drawn on a small piece of paper: a kind of inlay. Tree shadows, a wooden gate swinging in the wind, a black front door. When I went inside, the guests hadn't arrived yet, there was no-one there.

Two pieces of furniture stood alone, in the middle of the room. They looked like the closed doors to unknown worlds. From goodness knows where, the dazzling beam of a lighthouse pierced the darkness. I saw everything clearly.

The inlays! A sign to me: I was in the right place.

Marco Triches, march 2022

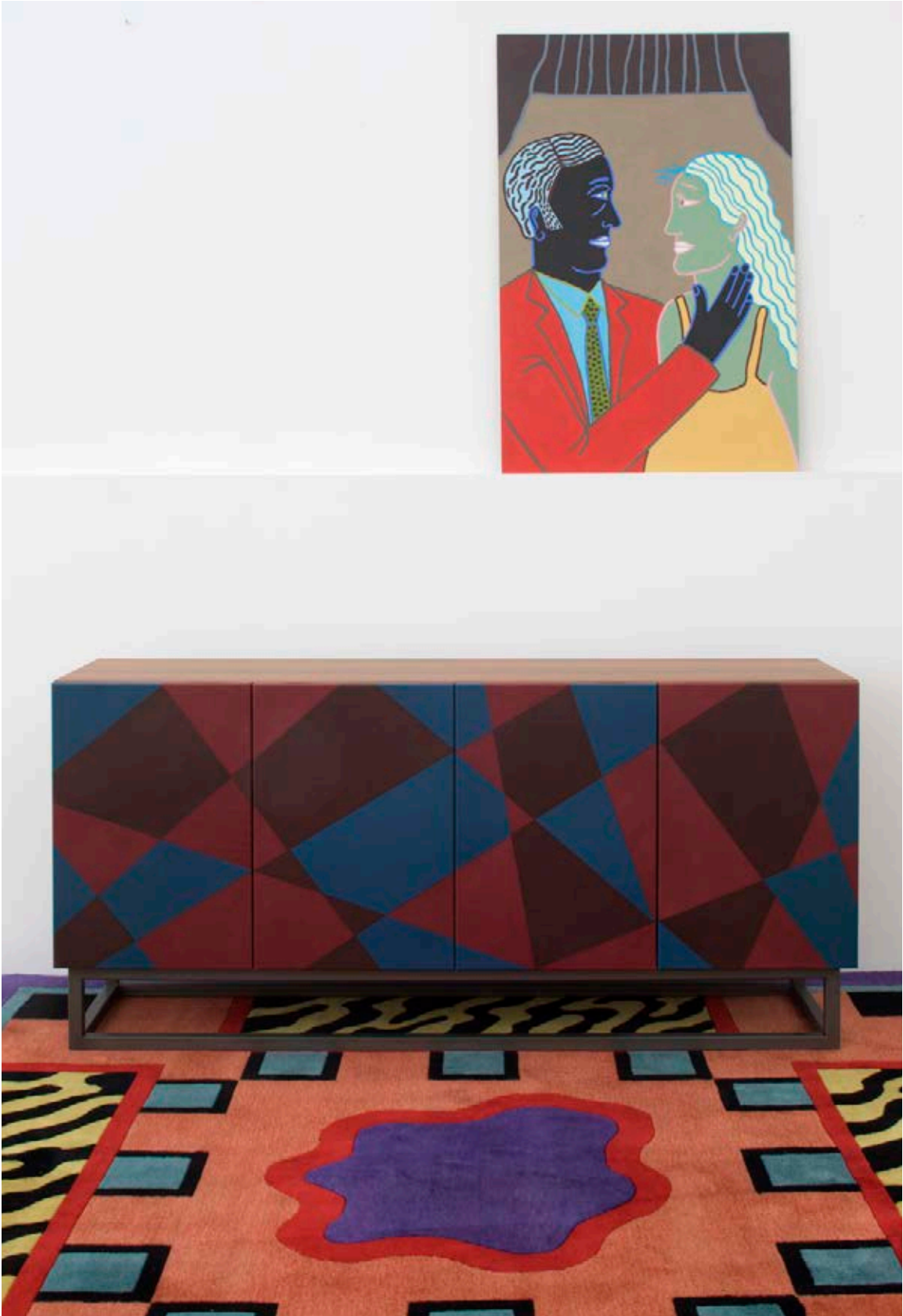

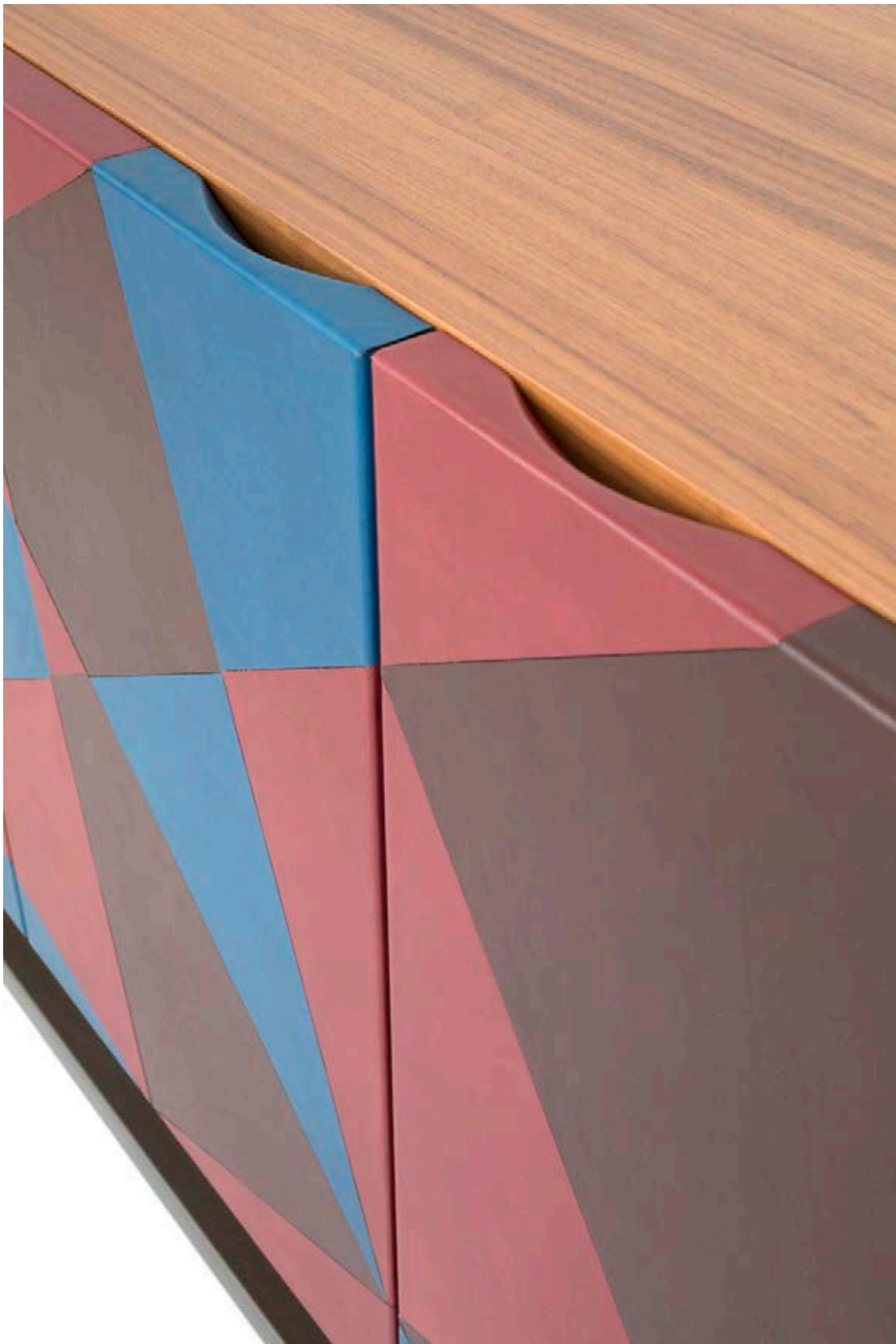

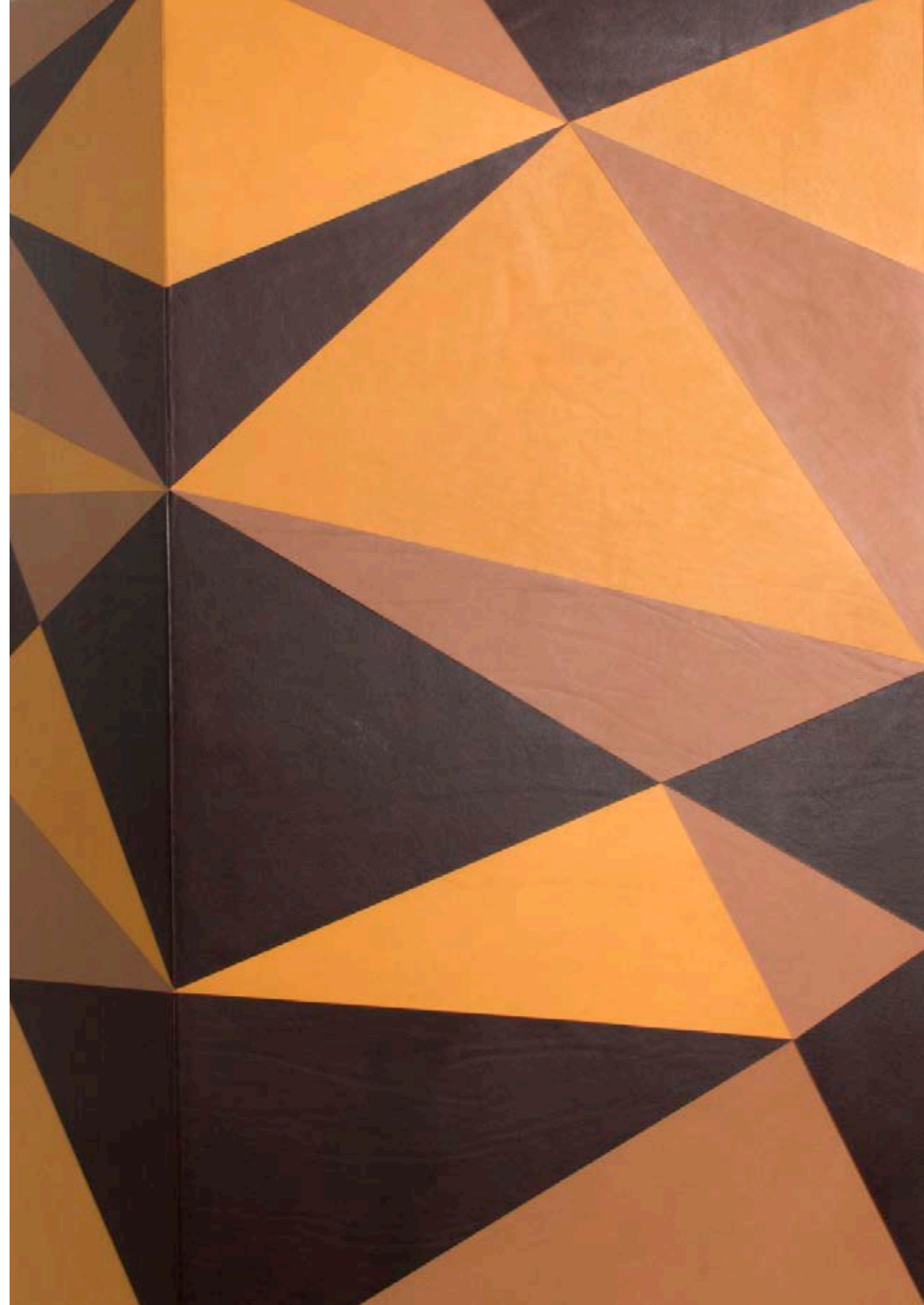

SEASONS SUMMER CABINET

Mobile contenitore in legno rivestito in cuoio

rivestimento in cuoio colori: suola / ocra / testa di moro
struttura in legno lamellare impiallacciato acero
base in acciaio verniciato a polveri epossidiche, finitura bronzo
opzioni rivestimento in cuoio: intero mobile o solo ante
Misure: 60 × 40 × h 160 cm

1MOB101

Storage furniture in leather-covered wood

clad with sole / ochre / dark brown leather
structure in laminated wood with maple veneer
base in steel, bronze finish, powder coated
leather cladding options: whole cabinet or doors only
Dimensions: 60 × 40 × h 160 cm

1MOB101



vista di fronte – front view

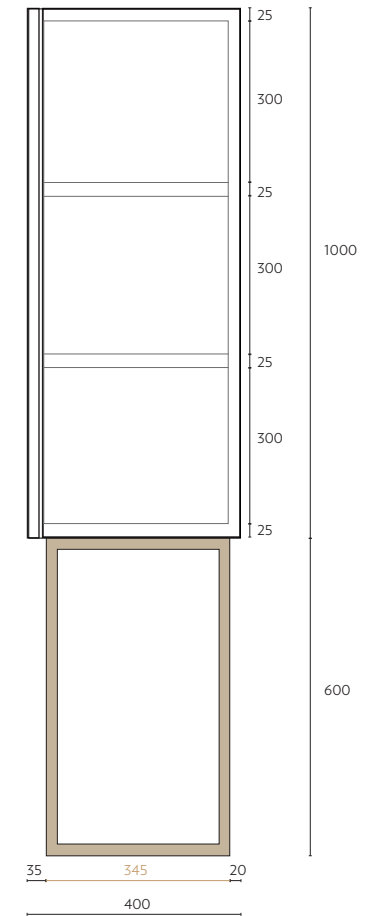

vista in sezione – section view

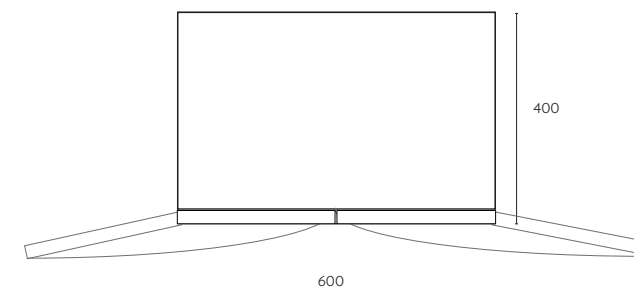

vista di pianta – plan view

SEASONS WINTER BUFFET

Mobile contenitore in legno rivestito in cuoio

ante rivestite in cuoio colori: blu / vinaccia / testa di moro
struttura in legno lamellare impiallacciato noce canaletto
base in acciaio verniciato a polveri epossidiche, finitura ferro
Misure: 140 x 40 x h 65 cm

1MOB100

Storage furniture in leather-covered wood

doors clad with blue / wine red / dark brown leather
structure in laminated wood with canaletto walnut veneer
base in steel, iron finish, powder coated
Dimensions: 140 x 40 x h 65 cm

1MOB100

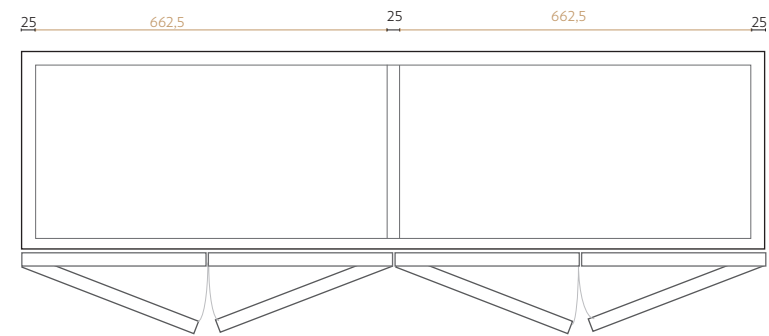

vista di pianta – plan view

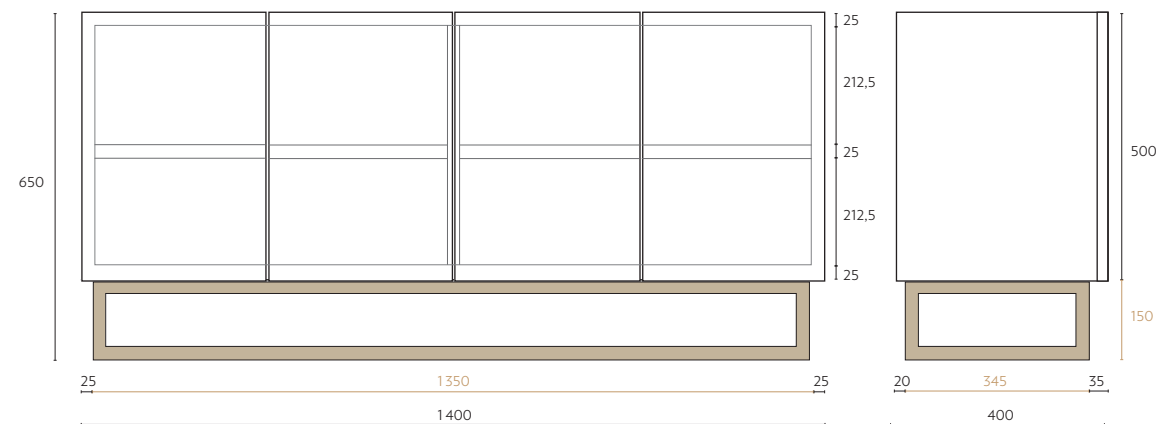

vista di fronte – front view

vista in sezione – section view



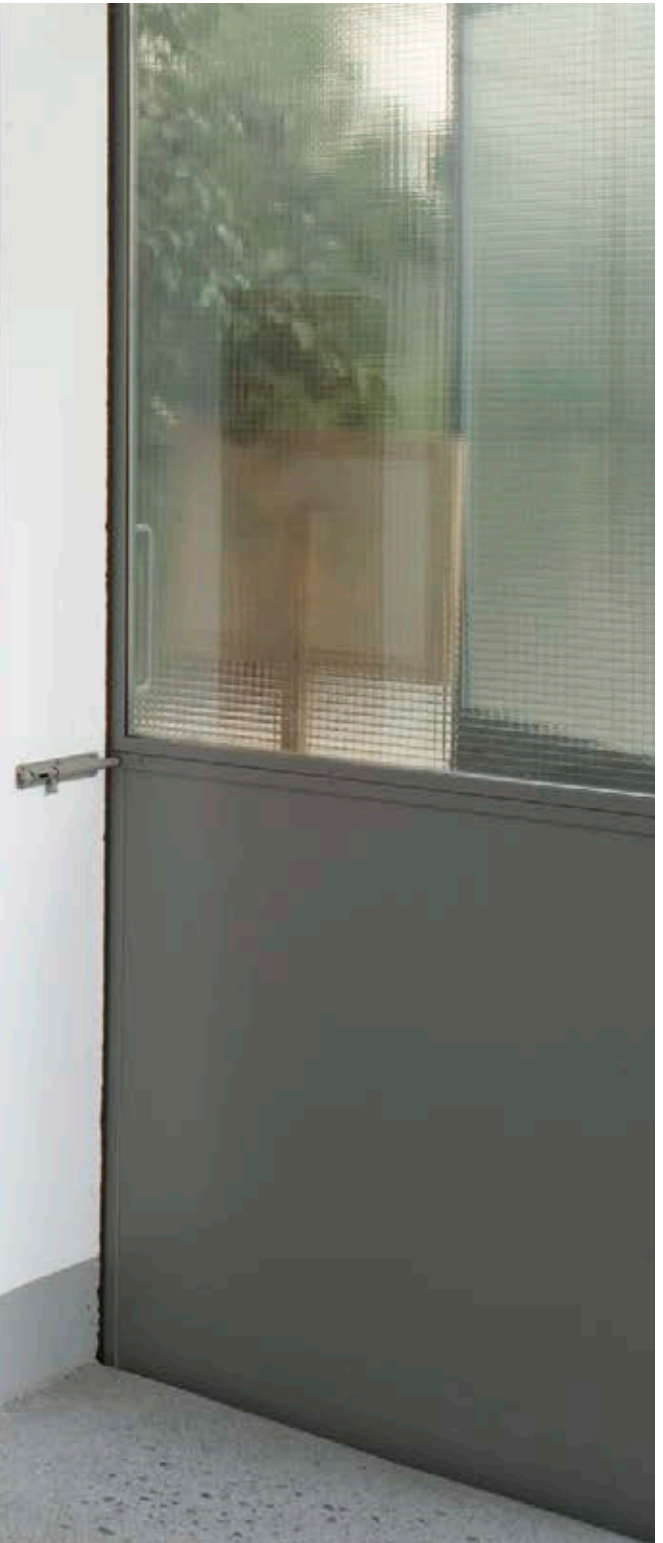

OSCARMASCHERA

Photos © Alice Fiorilli

Graphic design lunapark – atelier graphique

Pre-press Fotimprim, Paris

Print Grapho 5

Printed in Italy in 2022

Oscar Maschera snc

Strada S. Giovanni 1 / Candelara / 61122 Pesaro / (PU) Italy

ph. + 39 0721 206023 / fax + 39 0721 207238

info@oscarmaschera.com / www.oscarmaschera.com